

General Safety Information

WARNING – To avoid serious injuries:

- SPD pedals are designed so that you release them only when you intend to release. They are not designed to release automatically at times such as when falling off the bicycle. This is a safety measure to prevent you from losing balance and falling off the bicycle as a result of your feet becoming accidentally released from the pedals.
- Use only SPD shoes with this product. Other types of shoes may not release from the pedals, or may release unexpectedly.
- Use only Shimano cleats (SM-SH51/SM-SH52/SM-SH55/SM-SH56) and tighten the mounting bolts securely to the shoes.
- Before attempting to ride with these pedals and shoes, make sure you understand the operation of the engagement/release mechanism for the pedals and cleats (shoes).
- Before you attempt to ride with these pedals and shoes, apply the brakes, then place one foot on the ground and practice engaging and releasing each shoe from its pedal until you can do so naturally and with minimal effort.
- Ride on level ground first until you become adept at engaging and releasing your shoes from the pedals.
- Before riding, adjust the spring tension of the pedals to your liking.
- When riding at low speed or when there is a possibility that you might need to stop riding, (for example, when doing a U-turn, nearing an intersection, riding uphill or turning a blind curve), release your shoes from the pedal beforehand so that you can quickly put your feet onto the ground at any time.
- Use a lighter spring tension for attaching the pedal cleats when riding in adverse conditions.
- Keep cleats and bindings clear of dirt and debris to ensure engagement and release.
- Remember to check the cleats periodically for wear. When the cleats are worn, replace them. Always check the spring tension after replacing the pedal cleats and before riding. If you do not maintain both your shoes and cleats in good condition, release and engagement to the pedals could become unpredictable or difficult, which could result in severe injury.
- Be sure to attach reflectors to the bicycle when riding at night. Do not continue riding the bicycle if the reflectors are dirty or damaged, otherwise it becomes more difficult for oncoming vehicles to see you.
- Obtain and read the service instructions carefully prior to installing the parts. Loose, worn, or damaged parts may cause serious injury to the rider. We strongly recommend only using genuine Shimano replacement parts.
- If you have any questions concerning your pedals, contact a professional dealer.
- Read these Technical Service Instructions carefully, and keep them in a safe place for later reference.

CAUTION – To avoid serious injuries:

These pedals can be fitted with toe clips, but the toe clips should be removed when using the pedals as SPD pedals.

- BE SURE TO READ AND FOLLOW THE ABOVE WARNINGS CAREFULLY.**
- If the warnings are not followed, your shoes may not come out of the pedals when you intend or they may come out unexpectedly or accidentally, and severe injury may result.

NOTE:

- Before riding the bicycle, check that there is no play or looseness in the connection. Also, be sure to retighten the crank arms and pedals at periodic intervals.
- In addition, if pedaling performance does not feel normal, check this once more.
- Parts are not guaranteed against natural wear or deterioration resulting from normal use.
- For maximum performance we highly recommend Shimano lubricants and maintenance products.

These pedals have an SPD-type face on one side and a standard face on the other side.

Cleat types and using the pedals

WARNING

Do not use the pedals and cleats in any way other than as described in these Service Instructions. The cleats are designed to engage and release from the pedals when the cleats and pedals are facing forward. See below for instructions on how to install the cleats. **FAILURE TO FOLLOW THESE INSTRUCTIONS MAY RESULT IN SERIOUS PERSONAL INJURY.**

Single release mode cleats (SM-SH51/SM-SH52) and multiple release mode cleats (SM-SH55/SM-SH56) are available for use with these pedals. Each type of cleat has its own distinctive features, so be sure to read the Service Instructions carefully and select whichever type of cleat best suits your riding style and the terrain and riding conditions which you will encounter.

Engaging the cleats with the pedals

Press the cleats into the pedals with a forward and downward motion.

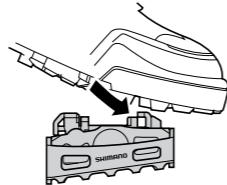

Releasing the cleats from the pedals

The method of release varies according to the type of cleats you are using. (Check the model number and color of your cleats to determine the proper method of release.)

Multiple release mode cleats: SM-SH55 (silver)/SM-SH56 (gold/silver)

The cleats can be released by twisting in any direction.

Because the cleats can also be released by lifting your heel, they may become accidentally released when applying upward force on the pedals.

These cleats should not be used for riding style which may involve pulling up on the pedals or for activities, such as jumping, in which pulling forces are applied to the pedals causing possible release from the pedals.

Although the cleats can be released by twisting your heels in any direction or by lifting, they will not necessarily release if you lose your balance.

Accordingly, for places and conditions where it looks as though you may lose balance, make sure that you have sufficient time to release the cleats beforehand.

If the cleats release by accident, you may fall off the bicycle and serious injury may result. If the features of multiple release mode cleats are not sufficiently understood and if they are not used correctly, then they may release accidentally with a greater frequency than for single release mode cleats.

You can help to prevent this by adjusting the amount of force required to release the cleats in any direction, and you should practice until you are accustomed to the amount of force and the angle required to release.

Multiple release mode

Release the cleats from the pedals by twisting your heels in any direction.

Note:

In multiple release mode, it is necessary to practice releasing until you become accustomed to the technique. Releasing by lifting your heel requires particular practice.

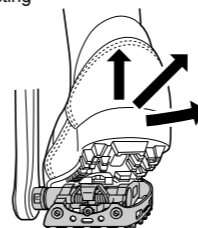

Single release mode cleats: SM-SH51/SM-SH52 (black/Optional accessory)

These cleats only release when the heel is twisted outward. They will not release if the heel is twisted in any other direction.

You are able to apply upward force to the pedal, since they will not release unless the foot is twisted outward.

The cleats will not necessarily release if you lose your balance. Accordingly, for places and conditions where it looks as though you may lose balance, make sure that you have sufficient time to release the cleats beforehand.

When you are pedaling vigorously, your heel may inadvertently twist outward and this may cause the cleat to release accidentally. If the cleat releases by accident, you may fall off the bicycle and serious injury may result.

You can help to prevent this by adjusting the amount of force required to release the cleats, and you should practice until you are accustomed to the amount of force and the angle required to release the cleats.

Single release mode

Release the cleats from the pedals by twisting your heels outward.

Note:

It is necessary to practice releasing until you become accustomed to the technique.

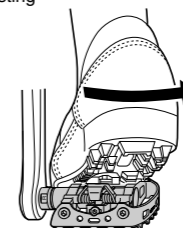

Adjusting the spring tension of the binding

The spring force is adjusted by means of adjustment bolts. The adjustment bolts are located behind each of the bindings, and there is one adjustment bolt on each pedal. Equalize the spring tensions by referring to the tension indicators and by counting the number of turns of the adjustment bolts. The spring tension can be adjusted in three steps for each turn of the adjustment bolt.

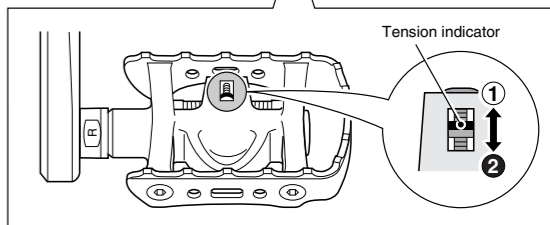
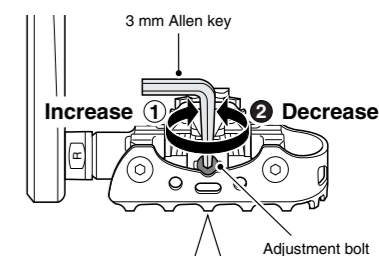

Strongest position

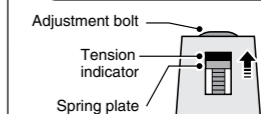

If the tension indicator is at the strongest or the weakest position, do not turn the adjustment bolt any further.

Weakest position



Note:

- In order to prevent accidental release from occurring, make sure all the spring tensions are properly adjusted.
- The spring tensions should be adjusted equally for both right and left pedals. If they are not adjusted equally, it can cause the rider difficulty to engage or release from the pedals.
- If the adjustment bolt is completely withdrawn from the spring plate, disassembly and reassembly will be required. If this occurs, ask a professional dealer for assistance.

PD-M324 SPD Pedals

Technical Service Instructions

Attaching the cleats

- With a pair of pliers or a similar tool, pull off the rubber cover to expose the cleat mounting holes.

Note:

This step may not be necessary depending on the type of shoes.

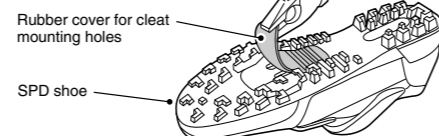

- Remove the sockliner and position a cleat nut over the oval holes.

Note:

This step may not be necessary depending on the type of shoes.

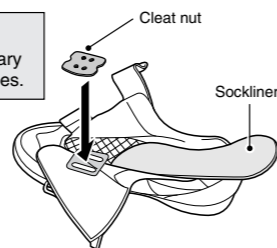

- From the bottom of the shoe, position a cleat and then a cleat adapter over the cleat holes. The cleats are compatible with both left and right pedals. Provisionally tighten the cleat mounting bolts.

Provisional tightening torque for cleat mounting bolts: 2.5 N·m {22 in. lbs.}

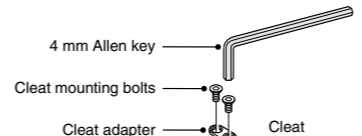

Front

Position the triangular portion of the cleat toward the front of the shoe.

Adjusting the cleat position

- The cleat has an adjustment range of 20 mm front to back and 5 mm right to left. After provisionally tightening the cleat, practice engaging and releasing, one shoe at a time. Readjust to determine the best cleat position.
- After you have determined the best cleat position, firmly tighten the cleat mounting bolts with a 4 mm Allen key.

Tightening torque: 5 – 6 N·m {43 – 52 in. lbs.}

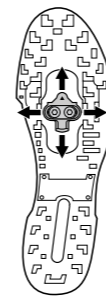

Waterproof seal

Remove the sockliner and attach the waterproof seal.

Note:

The waterproof seal is supplied with Shimano shoes which require this step to be carried out.

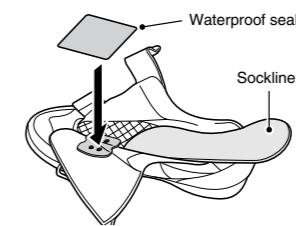

Mounting the pedals on the crank arms

Use a 15 mm spanner to mount the pedals on the crank arms. The right pedal has a right-hand thread; the left pedal has a left-hand thread.

Pay attention to the mark
R: right pedal
L: left pedal

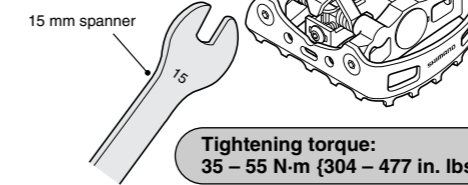

Note:

A 6 mm Allen key cannot provide a sufficient tightening torque. Always be sure to use a 15 mm spanner.

Mounting the reflectors (optional)

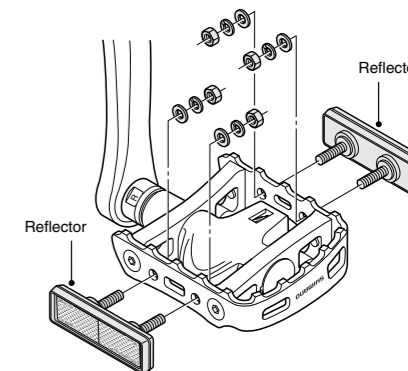

Cleat replacement

Cleats wear out over time and should be replaced periodically. Cleats should be replaced when it becomes difficult to release, or it starts to release with much less effort than when it was in new condition.

SHIMANO

SHIMANO AMERICAN CORPORATION
One Holland, Irvine, California 92618, U.S.A. Phone: +1-949-951-5003

SHIMANO EUROPE B.V.
Industrieweg 24, 8071 CT Nunspeet, The Netherlands Phone: +31-341-272222

SHIMANO INC.
3-77 Oimatsu-cho, Sakai-ku, Sakai, Osaka 590-8577, Japan

Please note: Specifications are subject to change for improvement without notice. (English)